

3D Printing



MARCO CALLIERI
ISTI-CNR

Chi sono?



Marco Callieri

- Master degree & PhD in computer science
- Researcher at the Visual Computing Lab, ISTI-CNR, in Pisa
- I work on 3D data manipulation and rendering... lot of experience in 3D scanning and data processing
- Most of my activities are in the field of cultural heritage

<http://vcg.isti.cnr.it/~callieri>

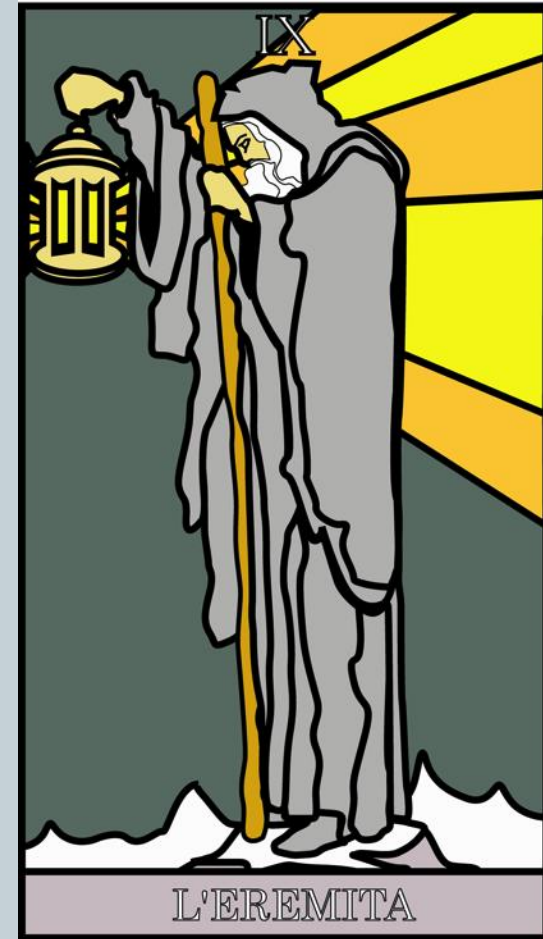

Beside this:

an eclectic artisan, an avid gamer, a former biker, a good cook, an incorrigible geek... and much more

Visual Computing Lab



Gruppo di ricerca dell'ISTI (Istituto di Scienza e Tecnologie dell'Informazione), istituto del CNR...

Siamo nell'area di ricerca di Pisa; siamo circa 20 persone, che lavorano su diversi aspetti della Computer Graphics

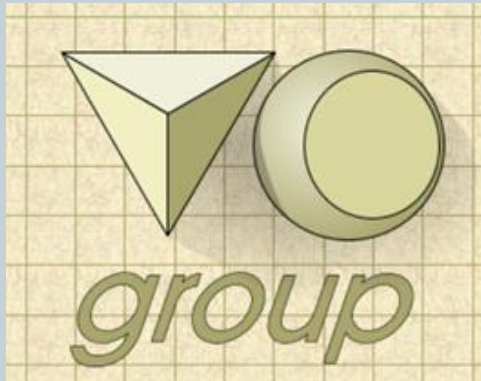

<http://vcg.isti.cnr.it>



Buzzword



3D Printing is a “buzzword”

buzz·word (bŭz'wŭrd)

n.

1. A word or phrase connected with a specialized field or group that usually sounds important or technical and is used primarily to impress laypersons

Everyone is talking about 3D printing, and seems everything may be solved with 3D printing... (just like “drones”, “social media”, “3D” ...)

The story so far



The problem is...

3D PRINTING IS NOT A NEW TECHNOLOGY

3D printing derives from a much *wider* and *older* family of technologies, called RAPID PROTOTYPING which, in turn, is a subset of of an even wider one, called CAM (Computer Aided Manufacturing)

Ancient Concepts



Subtractive

Additive

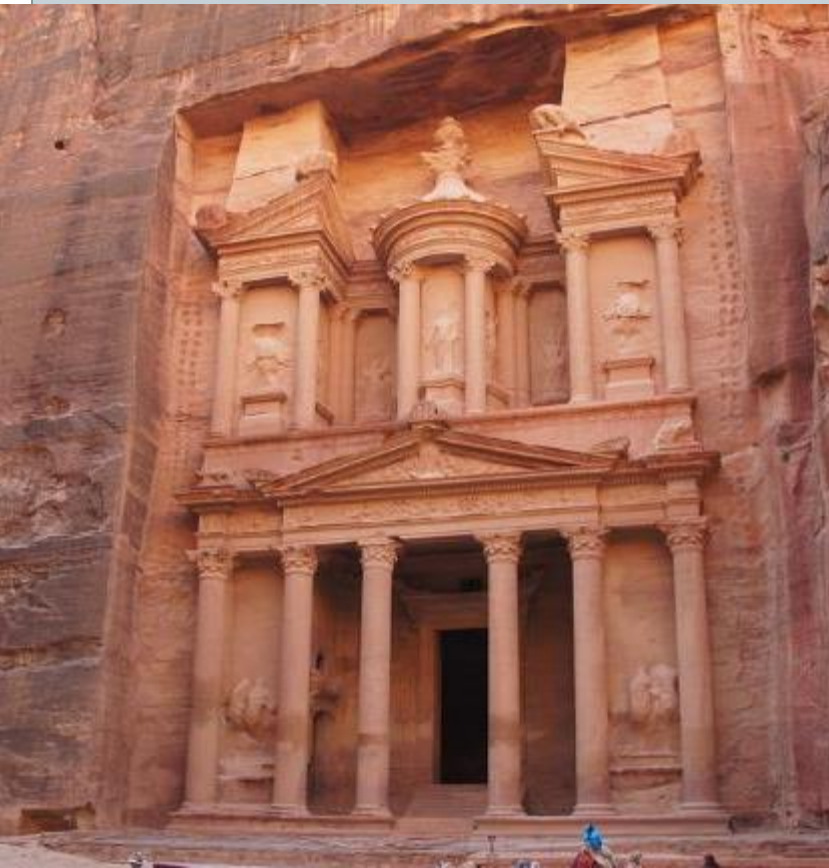

The story so far



The oldest CAM tools are simply a series of milling / cutting / drilling heads, controlled by a PC.

CNC machines are still used a lot today, and they can be considered the origin of the Rapid Prototyping...



The story so far



CNC machines, however, may only build a limited subset of geometries, depending on their working tools...

New machine could carve increasingly more complex objects

- 2.5 D drill/router (only produces a “height field”)
- 3-4-5-...N axis carving machines (tuttotondo)

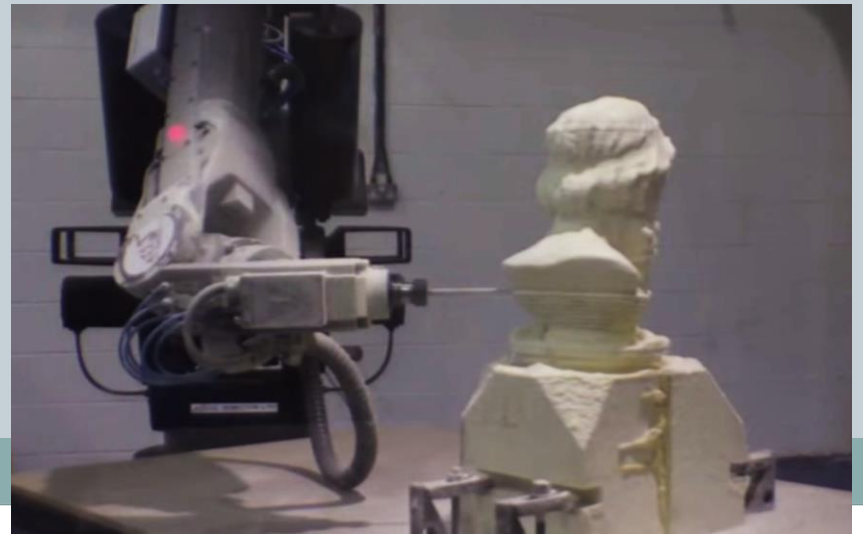

The story so far



Many different milling / carving techs.

Size and shape of the carving tool affect the quality of the results

- Bigger/rougher means faster
- Smaller and more precise means slower

Milling paths:

How to move the carving head

Over the surface of the object is
THE problem.

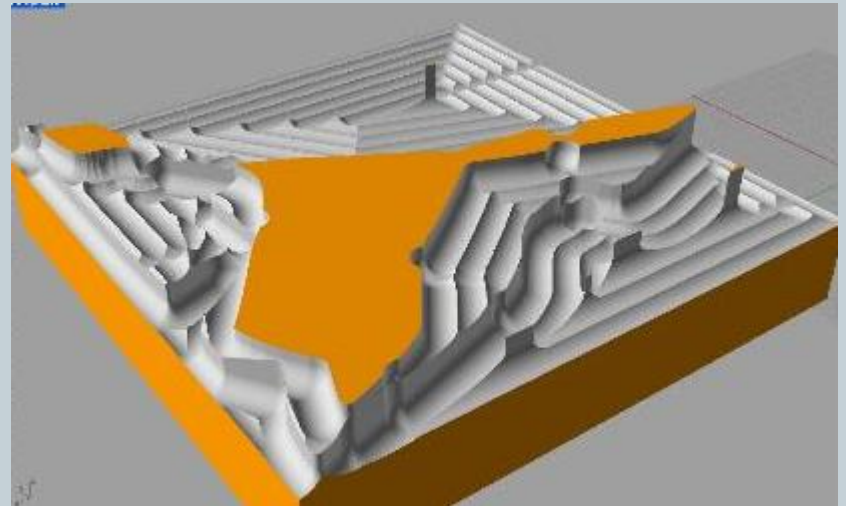

Up to a certain point, only SUBTRACTIVE technologies were available... then, came Stereolithography

Stereolithography (SLA)



The most famous old-school (1986) **additive** method for rapid prototyping: a liquid resin is solidified, layer by layer, using a laser.

Really costly, but creates incredibly detailed, sturdy objects

Used **a lot** in automotive!

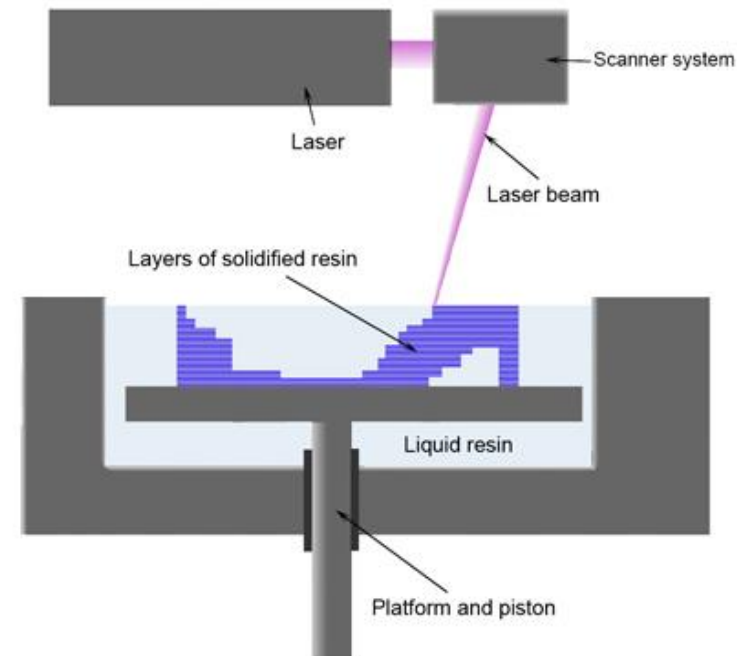

Stereolithography



Stereolithography



<http://www.materialise.com/>

One of the oldest and biggest companies providing additive rapid prototyping as a service (you provide the 3D model, they print it).

We used them years ago to make a David head.
They have the largest printing vats in the market !!



“almost” at home



Difficult to use at home... it uses laser, a vat full of resin, and require a lot of maintenance...

BUT

There are some experiments and new commercial printers to do “desktop” stereolithography... however, they are still in their infancy...

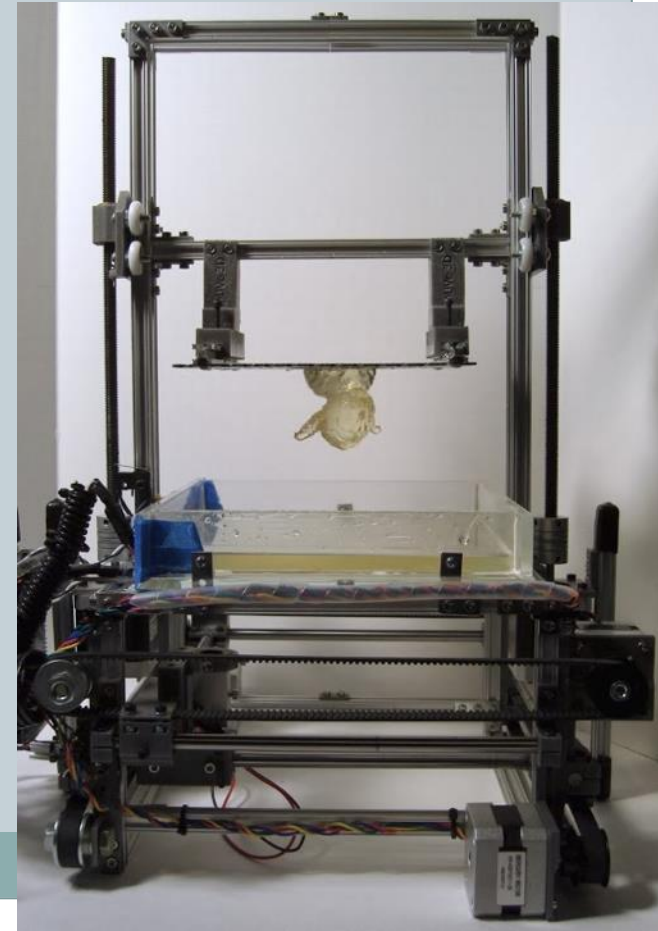

“almost” at home



<http://http://formlabs.com/en/products/form-1-plus/>



Other technologies

CHALK/powder printers

The printer deposits a layer of powder in a vat, then an inkjet head sprays glue on the “surface” of the object... Layer after layer the vat is filled, the object, now solid, is dug out from the powder...

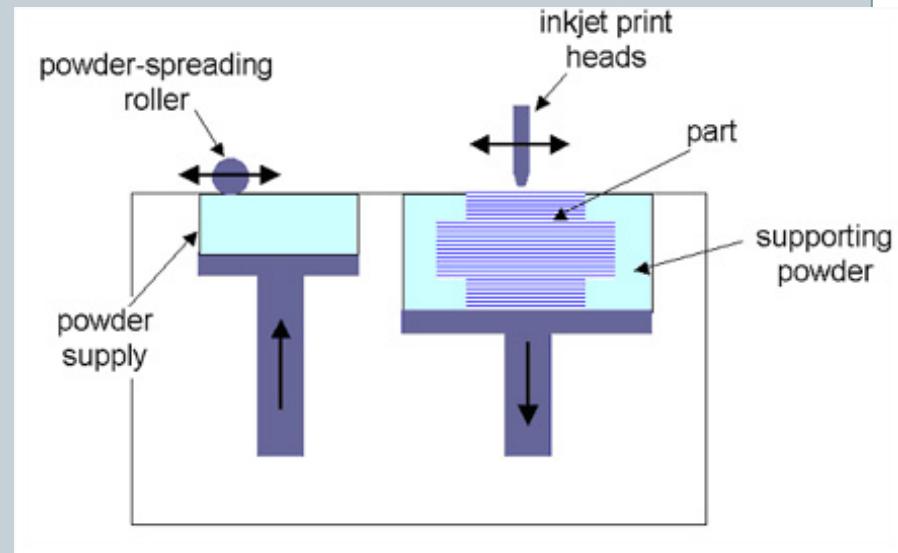
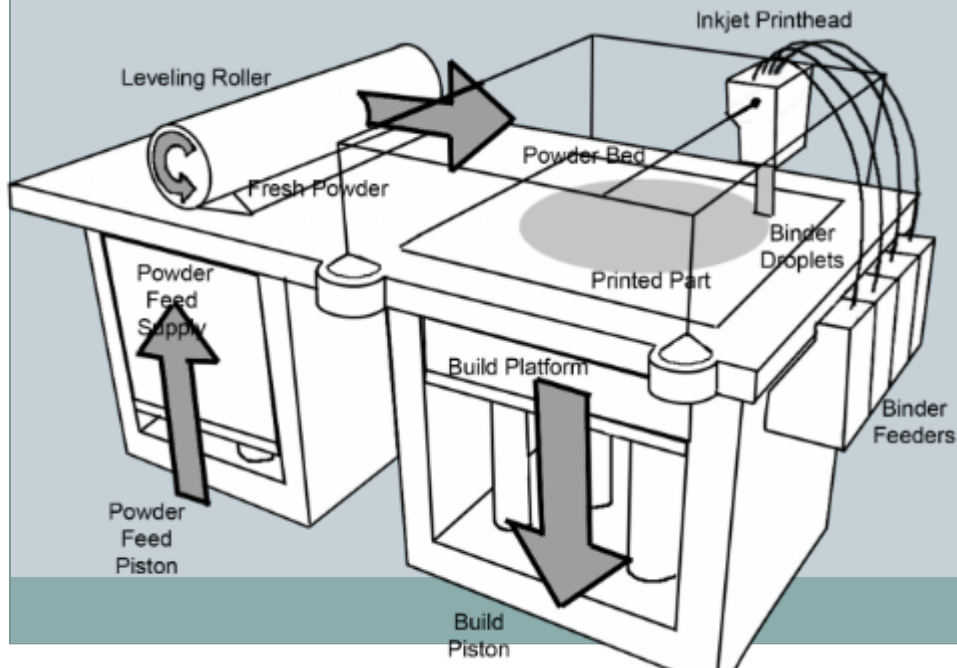

Other technologies



- No desktop use: industrial machine requiring maintenance
- Slow and high cost
- Fragile



- + High detail
- + Can do color prints
- + No problems with overhangs (I'll explain later)
- + The “feel” of the object is good for some markets

Other technologies

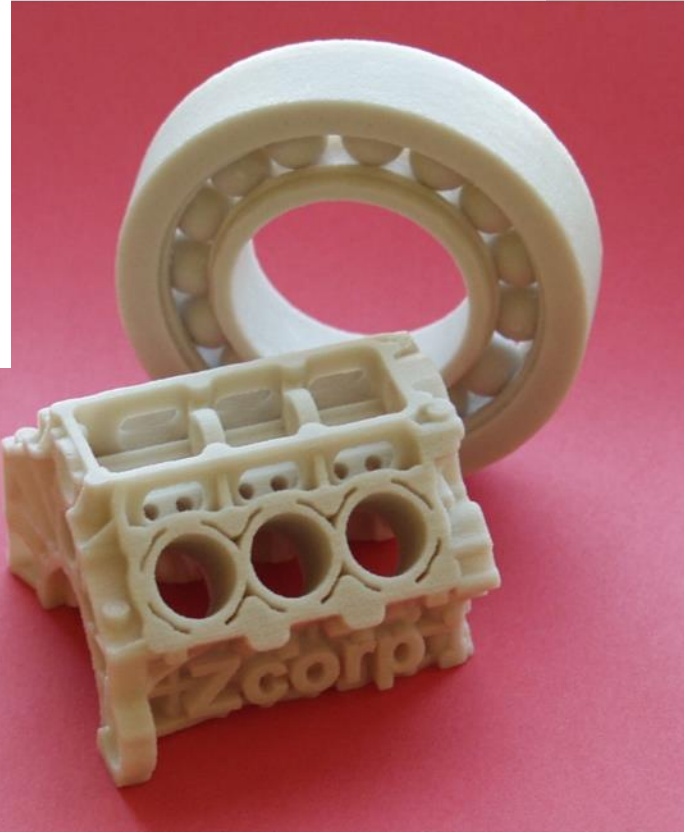

What happened, then



The current 3D printing trend is the result of different factors

- Industry developer new technologies for the creation of physical objects from 3D models
- Huge increase in the use of 3D models
- Cheaper hardware
- Popularization of the technology thanks to independent people aiming at developing open-hardware for 3D printing

3D Printing as we know it



3D printing, even if is used for any technology, is the name for all those technologies using an additive, layer by layer strategy, akin to “standard” 2D printing...

More specifically, with 3D printing, we generally indicate:

- Desktop, Do-It-Yourself, Home-safe printers
- Low cost approach (w.r.t. industrial solutions)
- ???

The “open” approach



A group of enthusiasts, technicians and researchers started designing a machine able to print itself (!!)

So... simple mechanism for depositing material, and simple architecture.

The project was called **RepRap**

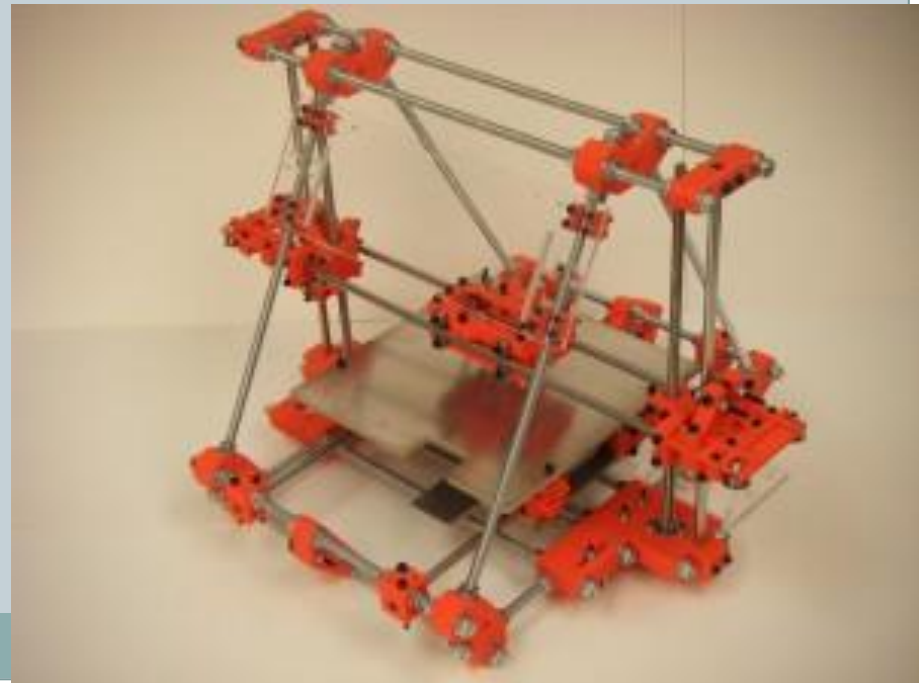

The “Fused Filament” method



It was necessary to find a printing method which was simple, easy to do with common hardware, suitable for a “desktop environment” ... **fused deposition modeling** (sotto copyright) o **fused filament fabrication**

- The printing material is plastic, stored as filament on a spool
- The material is heated to its melting point, and deposited in layers

(this method was also used in industrial printers)

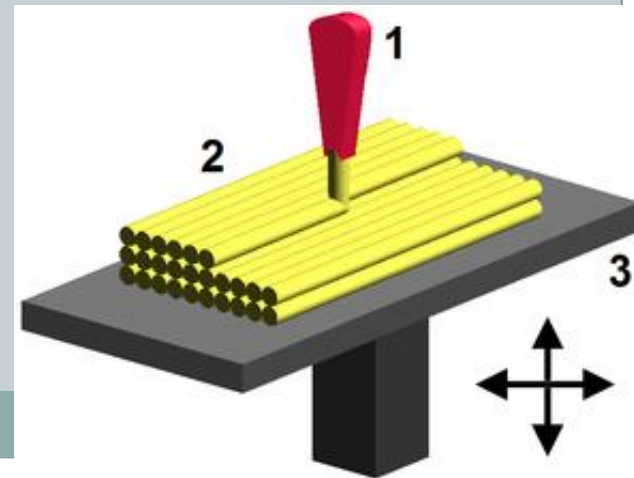

FDM

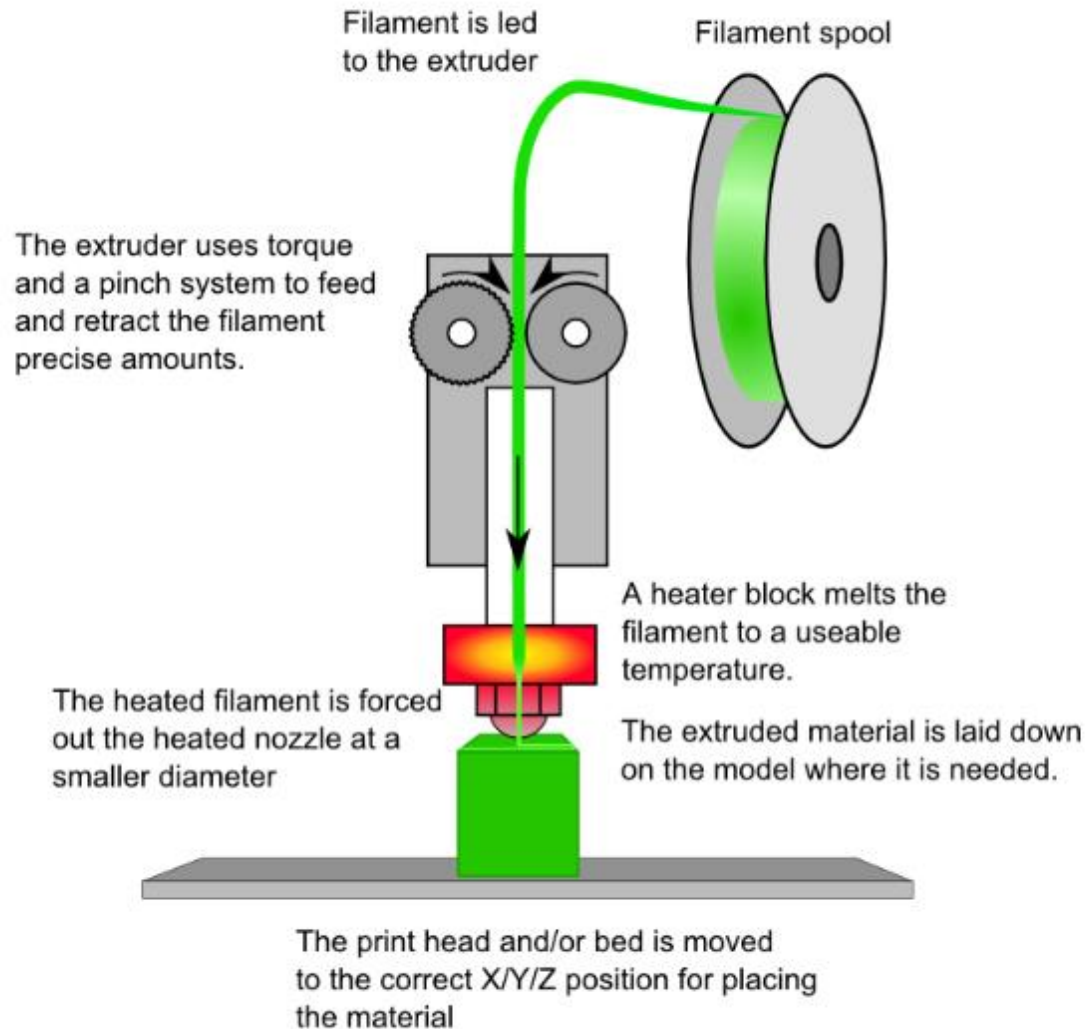

The “open” approach

The RepRap project evolved a lot in the years, now there are different “blueprints” for whole printers, electronic components for printers, extruders... There are many “derived” models, kits on sale, and companies/fablabs helping you build your own DIY printer...

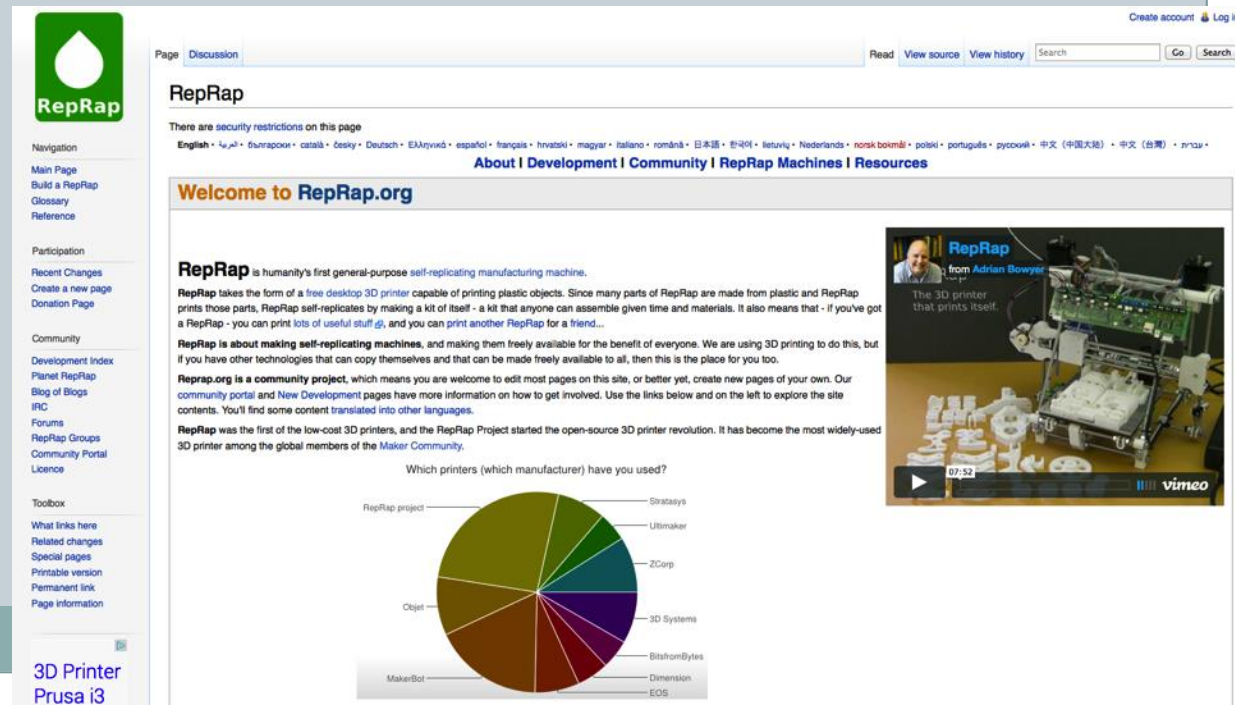

The screenshot shows the RepRap.org website interface. On the left is a navigation sidebar with sections for Navigation, Participation, Community, and Toolbox. The main content area features a 'Welcome to RepRap.org' message, a video player showing a 3D printer printing itself, and a pie chart titled 'Which printers (which manufacturer) have you used?'. The pie chart data is as follows:

| Manufacturer | Approximate Percentage |
|----------------|------------------------|
| RepRap project | 25% |
| Stratasys | 10% |
| Ultimaker | 10% |
| Z-Corp | 10% |
| 3D Systems | 10% |
| BitFromBytes | 5% |
| Dimension | 5% |
| ECS | 5% |
| MakerBot | 20% |
| Objet | 10% |

A Do-It-Yourself Printer



Prusa i3

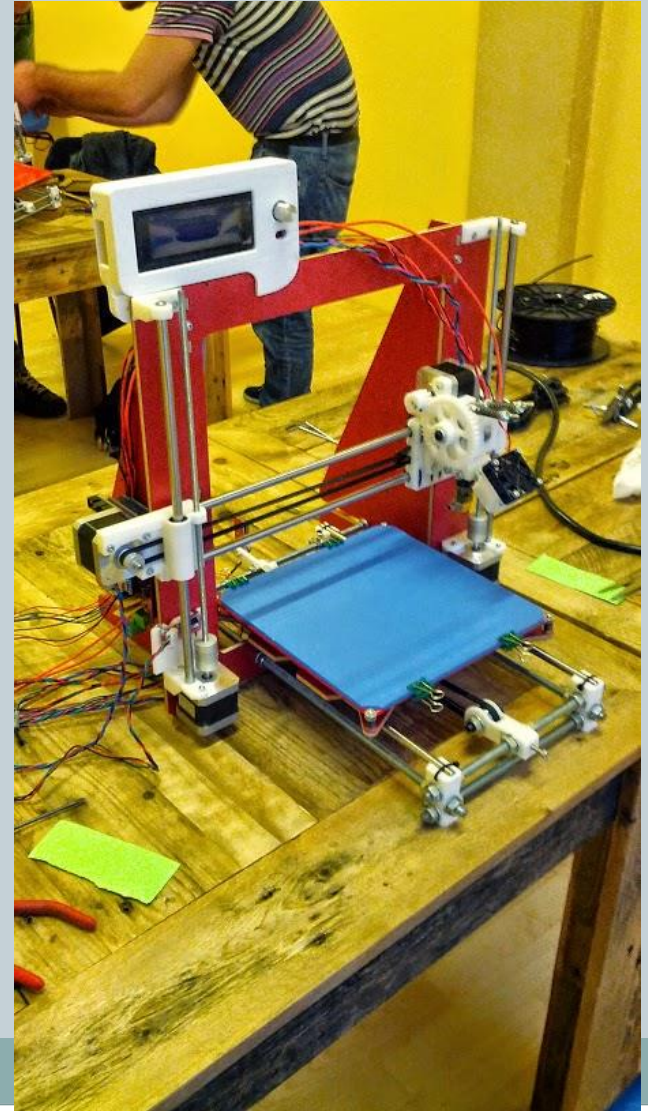
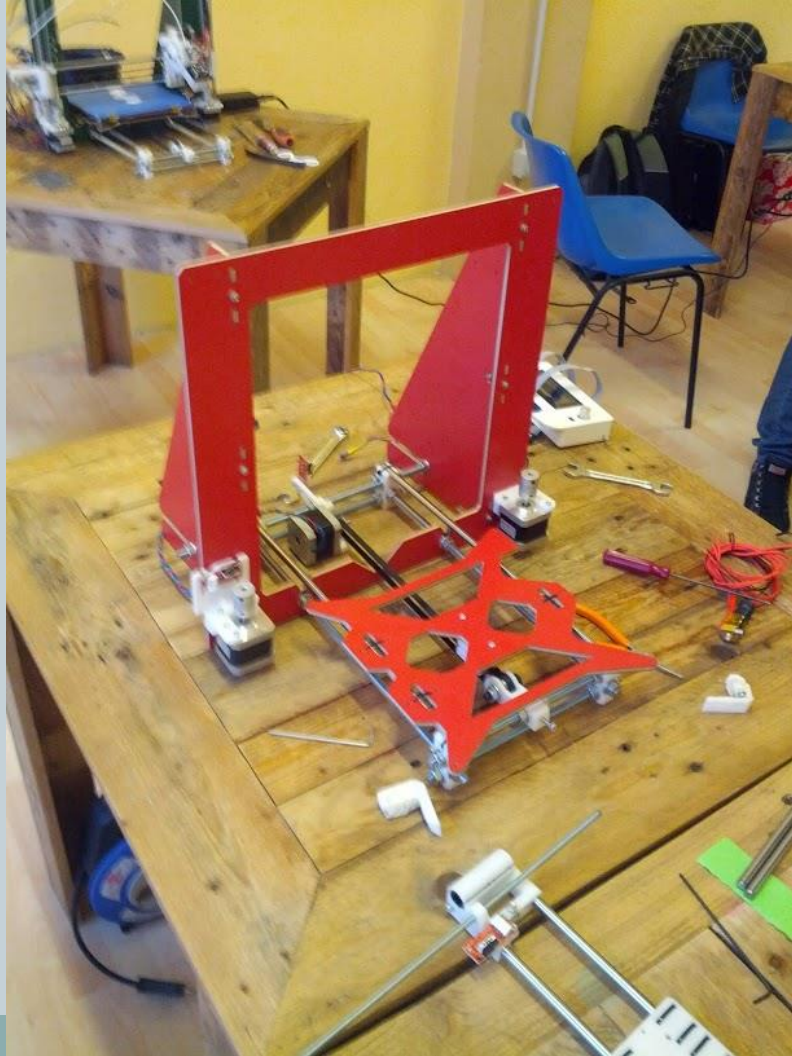

A Do-It-Yourself Printer



Prusa i3

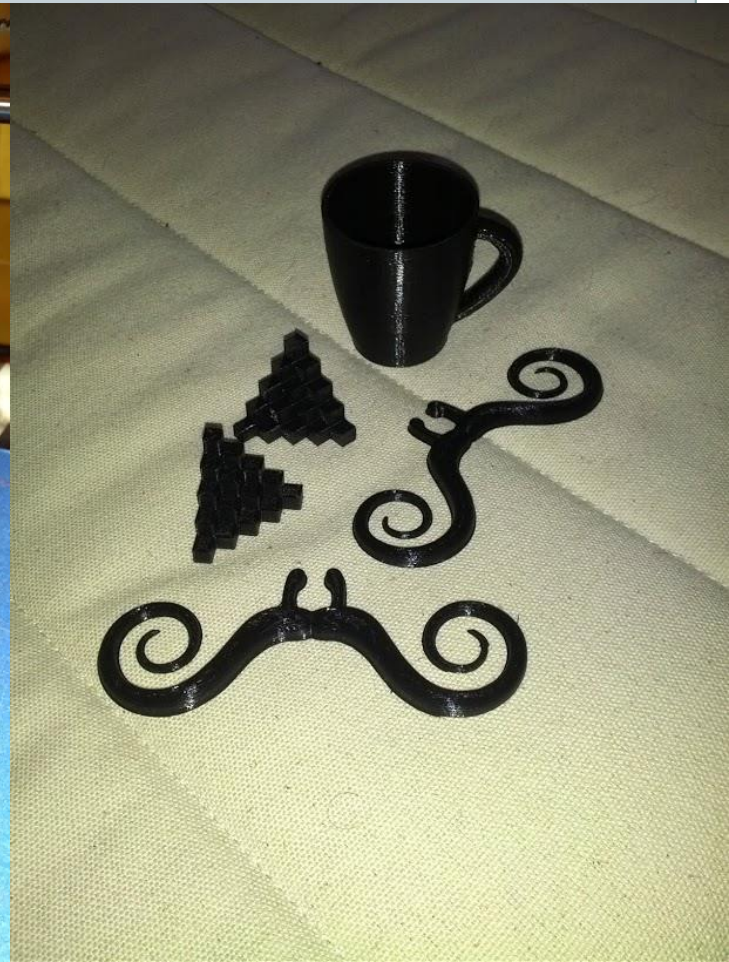
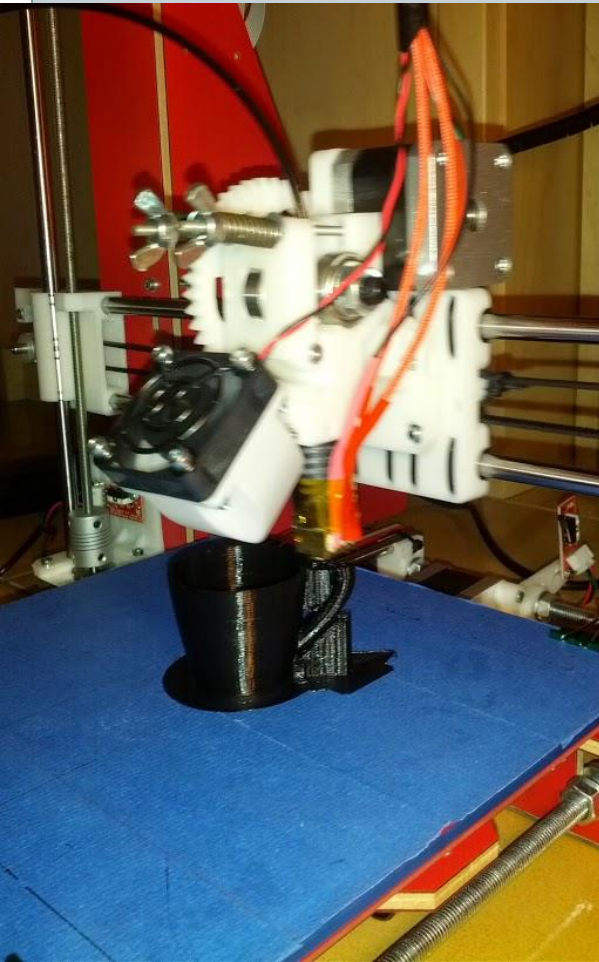

An entire ecosystem



Directly forking from RepRap, or inspired by it, a number of other 3D printers have sprouted...

Open, close, semi-open, open projects with closed parts, free software, open source software...

It is a **mess** just to understand what is available on the market

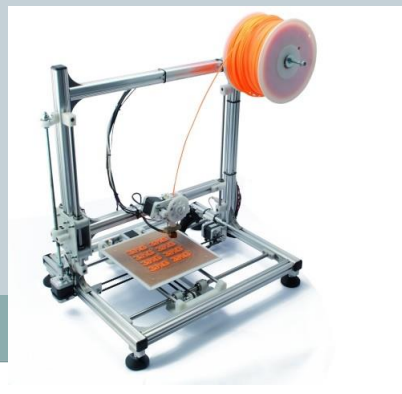
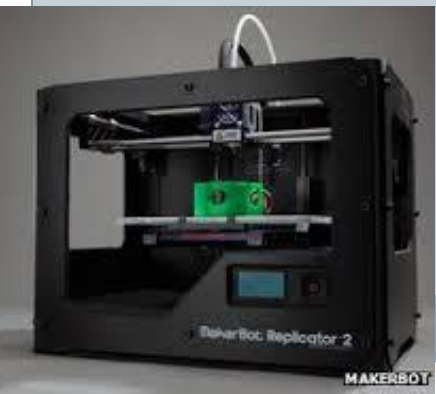

An entire ecosystem



- Beside the cost/print size/resolution.... Things to look for:
- Is the hardware open? Is it possible to open/dismantle the parts to clean/repair them?
 - Which material can I use? Can I use third part material?
 - Is the software included? Is it open? Can I use third-part software?
 - Can I manage the build/operation/maintenance ?

READ REVIEWS!!! Ask on forums... Internet is good to find reliable feedback

3D model



A printer needs a “printable” 3D model...

The requirements for the 3D models are many, we will describe them in detail in the next days.

Some are related to the shape and detail...

Some are more “basic”:

- Triangulated
- Closed (mostly)
- Shelled (maybe)
- Topologically clean (as much as possible)

3D model



- Not all 3 models are “directly printable”, but may require conversion/resampling/heavy edit
- When hand-modeling, there are strategies to create printer-friendly geometries

I will try to cover these points, but...

- There will ALWAYS be unprintable 3D Models

Before printing

The printer cannot directly handle a 3D model, but needs clear instruction on how to print it.

A conversion from a 3D Model to instructions is ALWAYS necessary. This process is called **slicing**.



Before printing



- Many slicing tools, from “single button” to extremely complex
- Different slicing tools will produce different results, some will not even be able to manage certain geometries
- Orientation of the 3D model DOES matter
- Knowing what happens in the slicing software helps a lot
- There will ALWAYS be unprintable geometries

Toolpath Generation

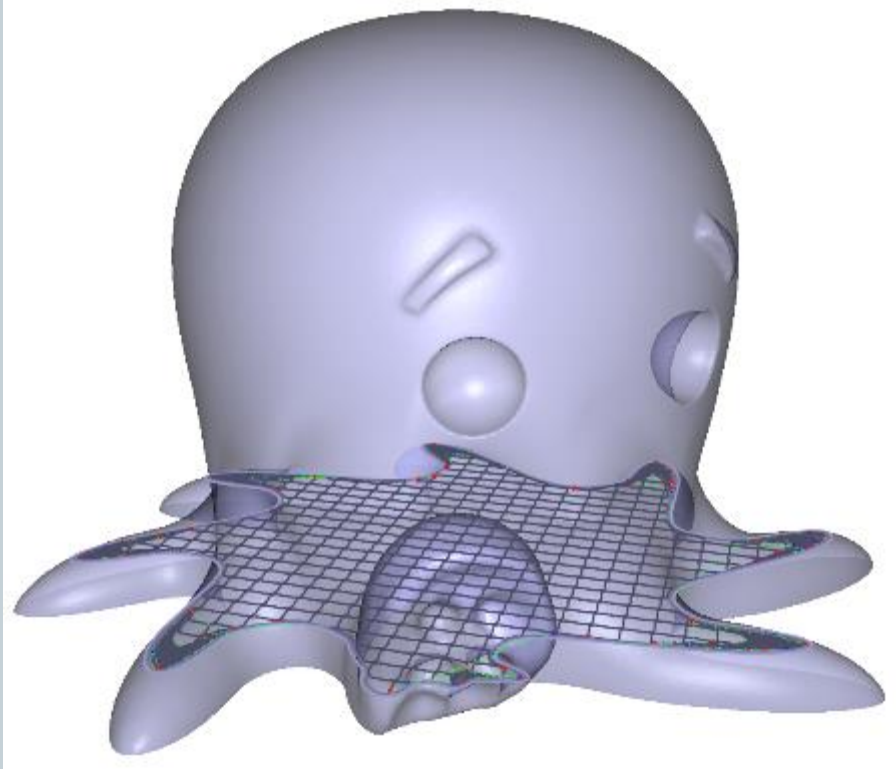

Toolpath Generation

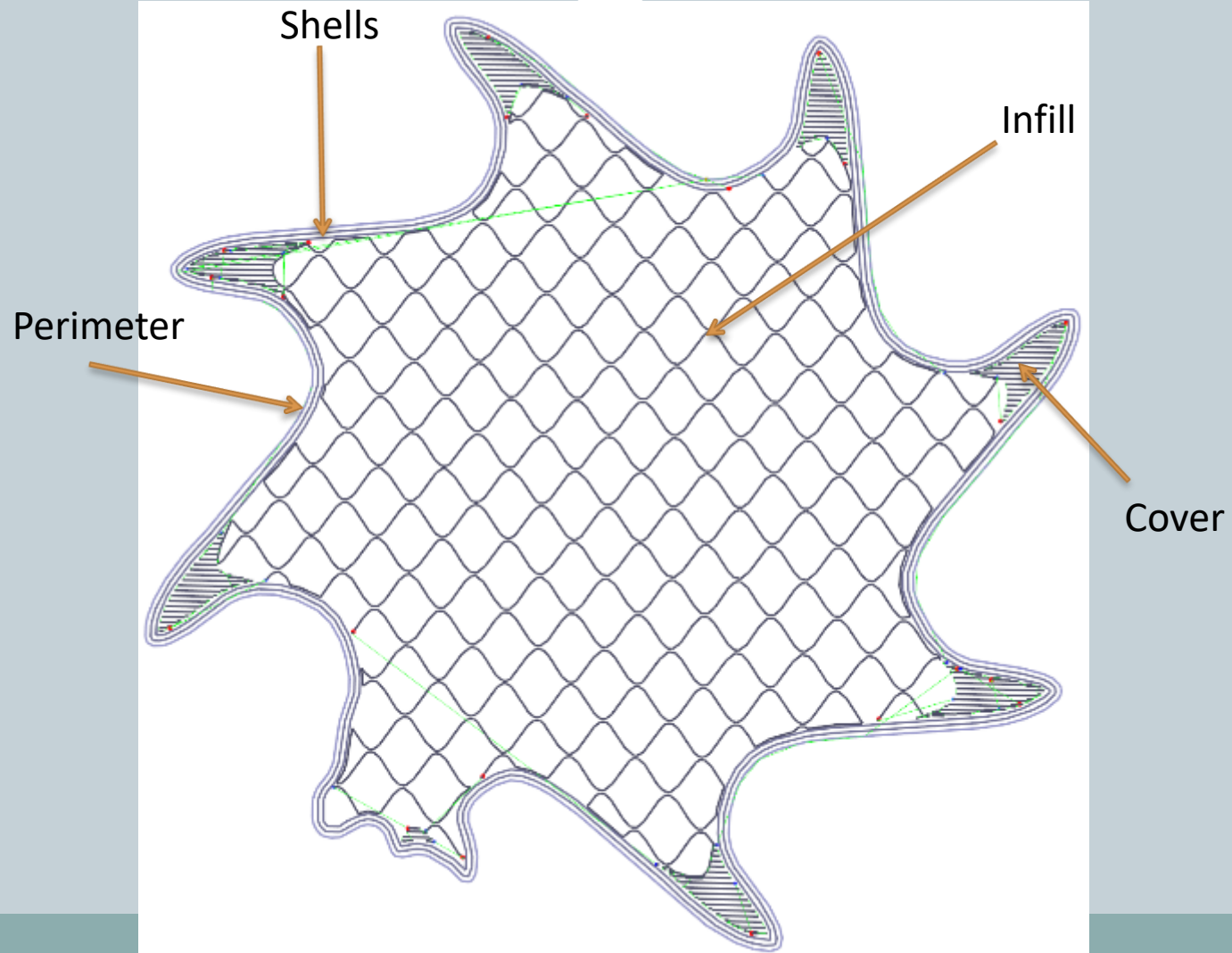

Infill



MAKERWARE 2.2.0: Infill Patterns



Linear

Hexagonal

Moroccanstar

Catfill

Objective: save material inside the object volume (and preserve strength)

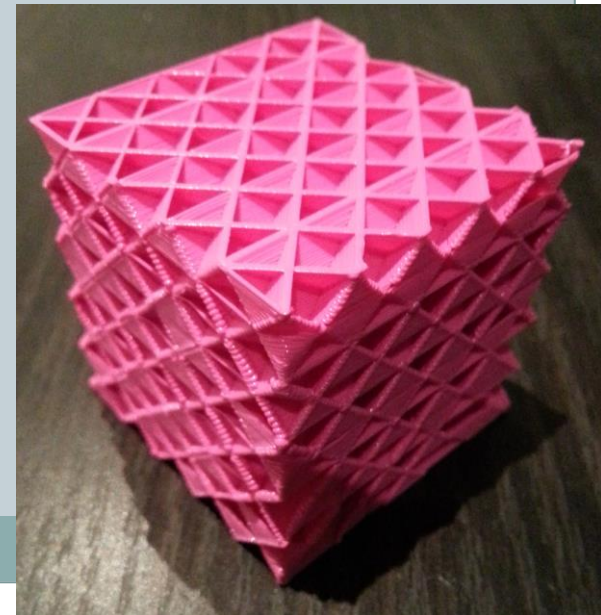

Support Structures



Deposited material is not self supporting!

- ❑ Automatic support generation done by most software tools
- ❑ Supports must be manually removed
- ❑ Some FDM's use a different support material (soluble)
- ❑ **In general:
FDM and SLA need supports!**

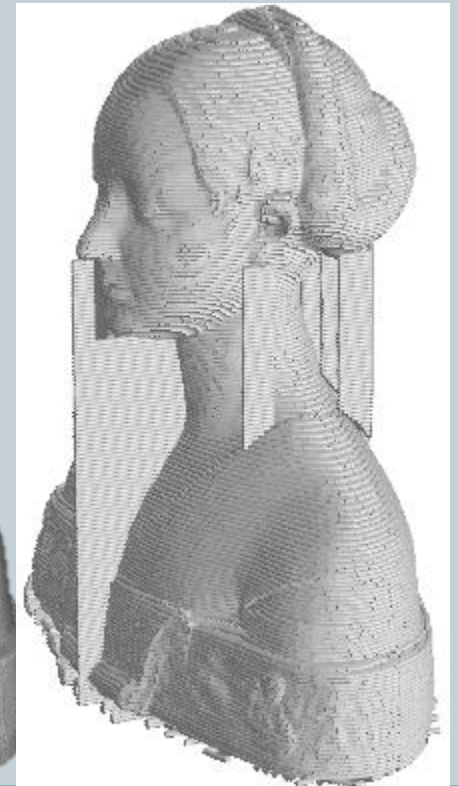

Support Structures



[Dumas et al. 2014]



[MakerWare software]



[Vanek et al. 2014]



[Autodesk MeshMixer]

Problems



- Overhangs

Layer by layer building has problems when geometry has outstanding parts, steep surfaces, undercuts

- Temperature

Plastic shrinks when cooling, curling/cracking the object. Too low temperature will not stick, too high will “bubble”

- Details/thickness

Even if the resolution of printer should handle them, most small details will disappear

Slicing



Layering is unavoidable

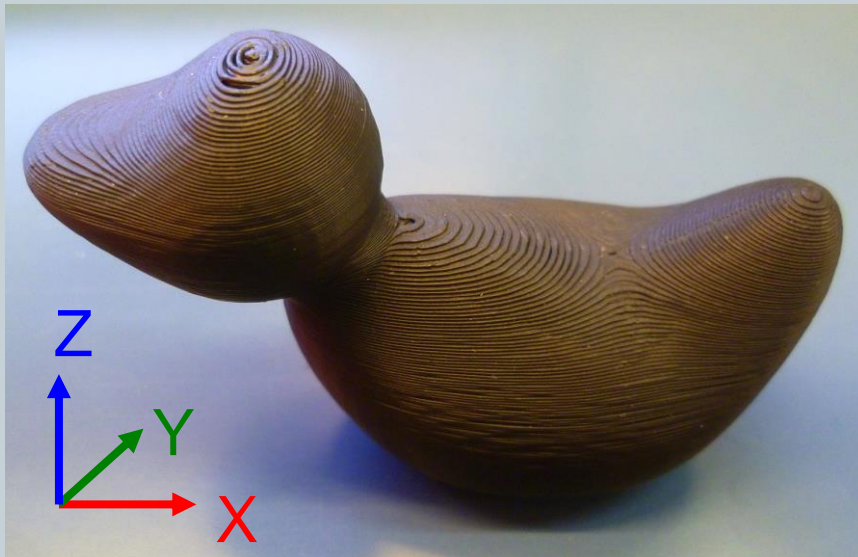
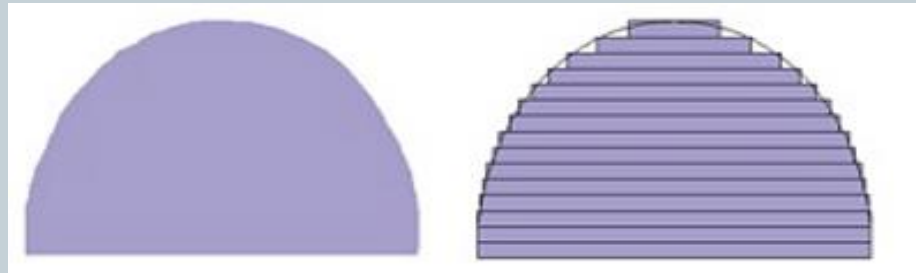

The precision is different between $\langle X, Y \rangle$ and $\langle Z \rangle$ axis

Slicing

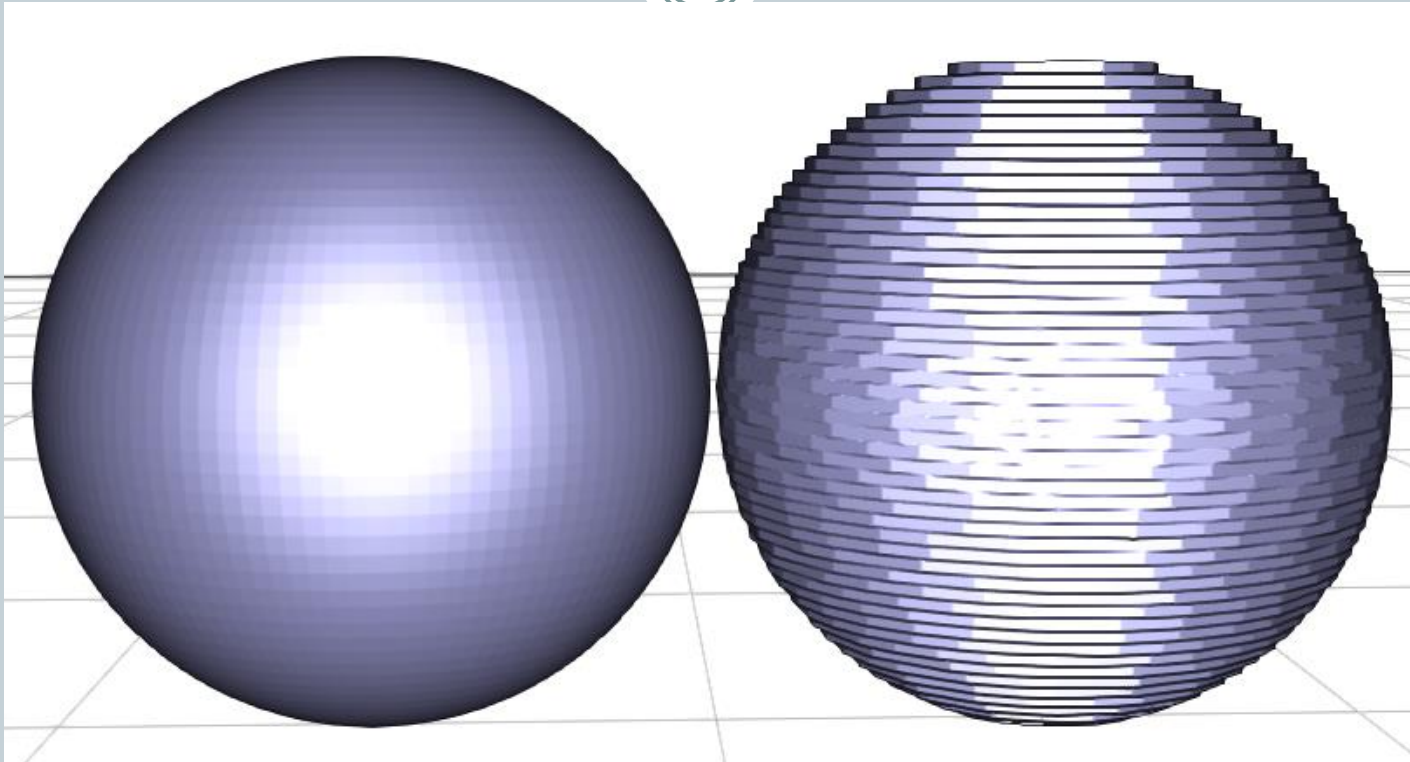

Lower layer thickness => Higher quality => Higher printing time

- 0.4 mm -> 1h
- 0.2 mm -> 3h
- ...

Problems



- Overhangs



MakerBot
MakerWare 2.3

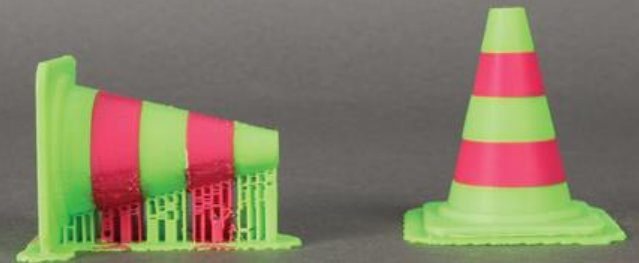

Problems



- Temperature

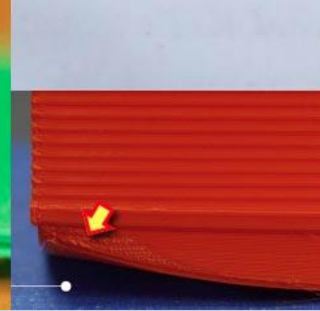
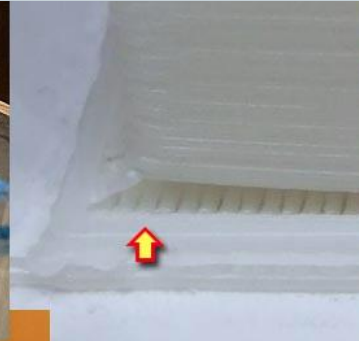
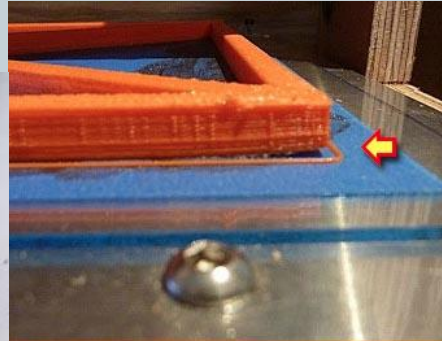

Not for home



We already saw 2 technologies not good for home/desktop printing...

- StereoLithography
- Powder printer

They are not the only ones...

All of them, however, are generally available through servicing...

Other technologies



Paper printers

A sheet of paper at a time is cut, color printed and glued to the underlying one.

Good, solid results, no problem with overhangs, colored output, wastes a lot of material, but is fully recyclable



Other technologies



Laser cutter

Not strictly 3D printing, but still in the family.. 2D technique, but can be used for 3d objects

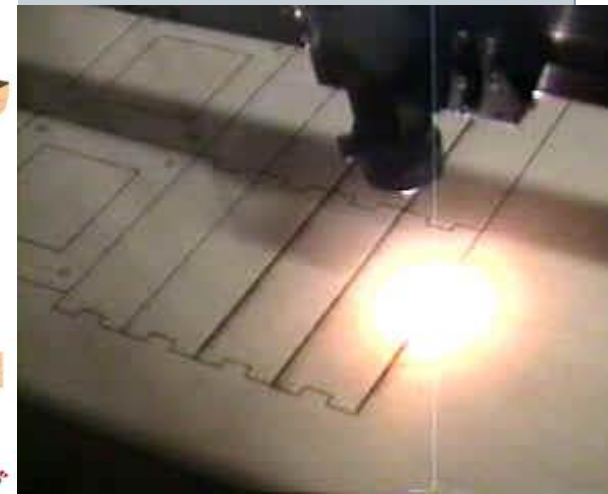

Other technologies



Ceramic printers

The printer works more or less like a FF plastic printer, but deposit CLAY, that is then fired in a kiln



Other technologies

METAL printers

The printer works more or less like a FF plastic printer, but deposit metal powder+resin, that is then fired in a kiln... OR a porous substrate, which is then infiltrated with molten metal... OR it works like the powder printer, but the top layer is fused on the underlying one (see next slide).

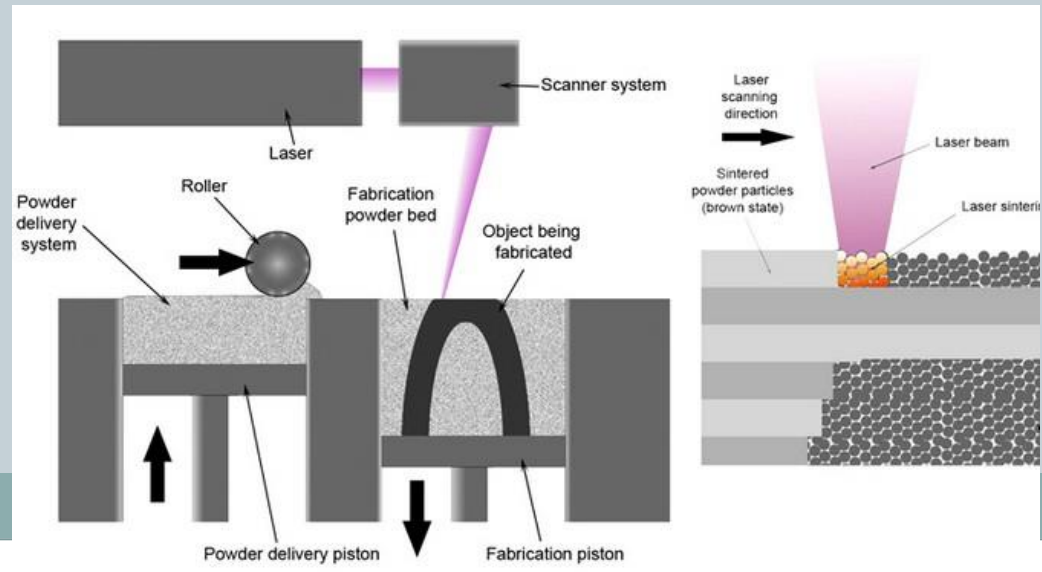

Other technologies



SINTERING printers

Metals, plastics, hybrid materials... a laser “almost” melt a layer of material on top of another



And so on...



Printing using many kind of **resins**

Sugar/chocolate/food printing

Gold/Silver printing

In most case, however, they use a variant of one of these techniques...

Controversy

Despite all the good things 3D printer can do, one thing was all over the newspapers last year:

THE 3D PRINTED GUN

Mostly, it was media stunt AND a Provocation of makers...

Anyone with a drill press / lathe may build a gun (much better than this one)

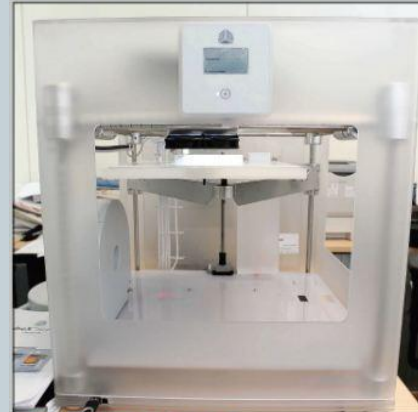

1 THE £1,700 PLASTIC PRINTER

WE purchased a £1,700 printer from the internet. The gun's blueprint was downloaded on to a computer, and then a memory stick was inserted into the 3D printer. It built up the design from layers of quick-setting plastic.



3 THE SIMPLE ASSEMBLY

USING simple DIY tools, each piece was filed and sanded to remove excess plastic, then the pistol's parts were assembled in just a matter of minutes.

2 THE DEADLY, PRECISION-MADE PARTS

IN LESS than 36 hours we had printed 15 plastic components. The final piece – a common nail which acts as a firing pin – was bought from a hardware shop. It is the only metal part of the finished gun.

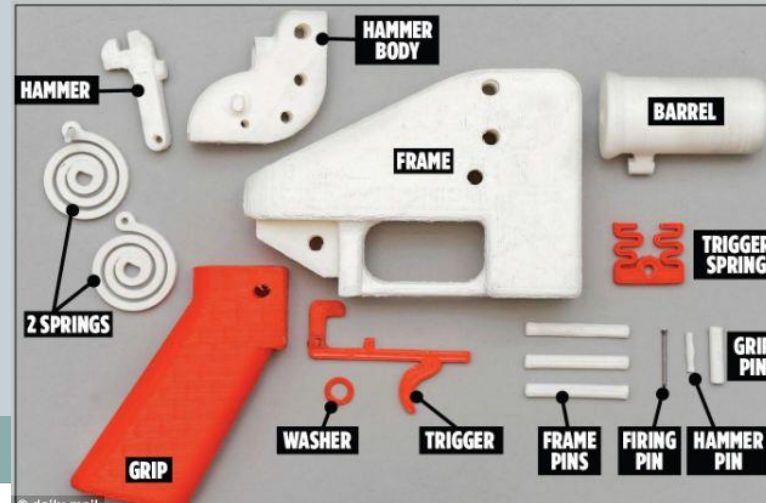

Things to see



The internet is full of resources for people interested in 3D printing, I will try to point out some basic resources lesson by lesson...

- RepRapWiki

<http://reprap.org/wiki/RepRap/it>

- Make magazine

<http://makezine.com/>

- Instructables

<http://www.instructables.com/>

Thingiverse



<http://www.thingiverse.com/>

Free repository of printable objects, great resource for ideas, advices on printing, examples, reviews

The screenshot shows the Thingiverse website interface. At the top, there is a navigation bar with the MakerBot Thingiverse logo, links for DASHBOARD, EXPLORE, and CREATE, a search bar with the placeholder text "Enter a search term", and a SIGN IN / JOIN link. Below the navigation bar is a large featured image of a glowing, cube-shaped lamp made of white and black parts. To the right of this image is a "Thingiverse Featured" section with a sub-heading "Featured" and a paragraph of text: "First prize in the #ModioChallenge goes to ibudmen's Modio Lamp. The illuminating design takes Modio components to a completely new place and even allows for personalized versions by incorporating a Customizer." Below this text is a "Learn More" button. Below the featured image is a "Global Feed" section titled "Latest Thingiverse Activity" with a list of recent user actions: "Aviv3d liked Ping Pong Desk Cannon", "Sicorsky collected Valentine Box", "Aviv3d liked Ping Pong Desk Cannon", "oneil liked MOD 3 way 90 degree housing", "oneil collected MOD 3 way 90 degree housing", and "Sicorsky collected Heart Box with Hinged Lid". To the right of the Global Feed is a "Featured Collections" section titled "Download and print today" with a "see more" link. It displays a grid of nine collection thumbnails: "Thanksgiving" (a red box with a yellow note), "Adorabots" (a small robot), "Zampach" (a blue and red object), "Modio Challenge" (a white drone-like object), "Tiny Computers" (a blue box), "Cosplay" (a colorful, curly object), "Ikea Hacks" (a black and white object), and "Accessibility" (an orange, lattice-like object).

Shapeways



<http://www.shapeways.com/>

Online service for 3D printing... you upload the model, choose the material, and order it

Not super cheap, but fast and reliable

The screenshot shows the Shapeways website interface. At the top, there are navigation links for 'Shop', 'Make + Sell', and a search bar. Below the navigation, there's a banner for 'Buon Natale' with shipping dates. The main content area features a product listing for 'Strandbeests' designed by Theo Jansen. It includes a video player showing a 3D printed model. Below the video, there are links to 'See Gracillis' and 'See Larva'. The bottom section is titled 'Shapeways Staff Holiday Picks' and displays a grid of six featured products with their names, prices, and creators.

Strandbeests

Designed by [Theo Jansen](#)

Meet the newest members of Theo Jansen's Strandbeest 3D Printed Animal Family.

[See Gracillis](#)

[See Larva](#)

Shapeways Staff Holiday Picks

- Cuttlefish Bottle Opener**
€112.87 by Bathsheba
- hand heart**
€18.47 by harrypeman
- Simensays Foldable Landing Gear for DJI...**
€38.21 by simensays
- Mech Heart Ring Size 10**
€33.98 by Coretta
- Clip on vase**
€12.13 by aleksandar
- A.N. Key Holder**
€26.67 by arthurditler

What about subtractive ?



Require much “harder” hardware, and it is not usable in a desktop environment. May go larger in size, but this require even costlier hardware

However, it is still widely used... the advantage is that it is possible to use different material... e.g. it is possible to carve **STONE** to replicate shape & material of a statue in the Cultural Heritage field, or metal for industrial applications

Robot sculpting



You will be surprised to know how many sculpting robots are active in the Carrara area... most of them just for the initial steps, but some for the complete sculpting process...



Robot sculpting

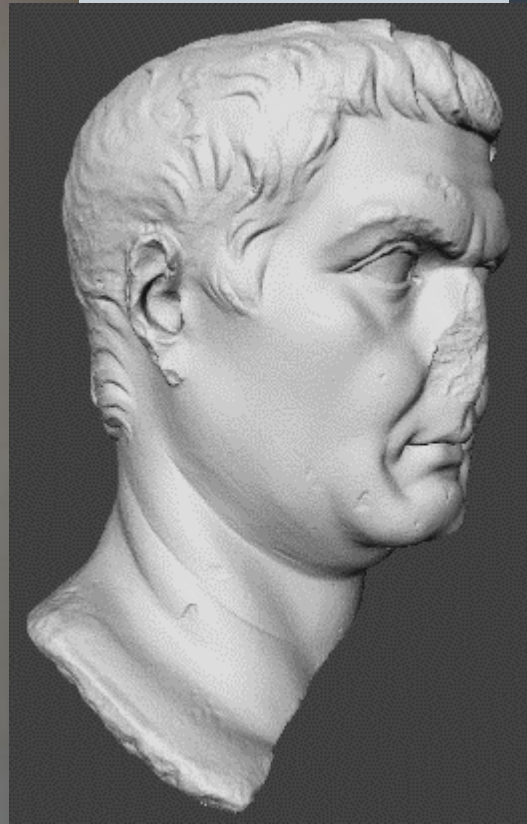

At home ?



Some cheap do-it-yourself CNC, a couple of commercial products... however, still much more messy than FF printing

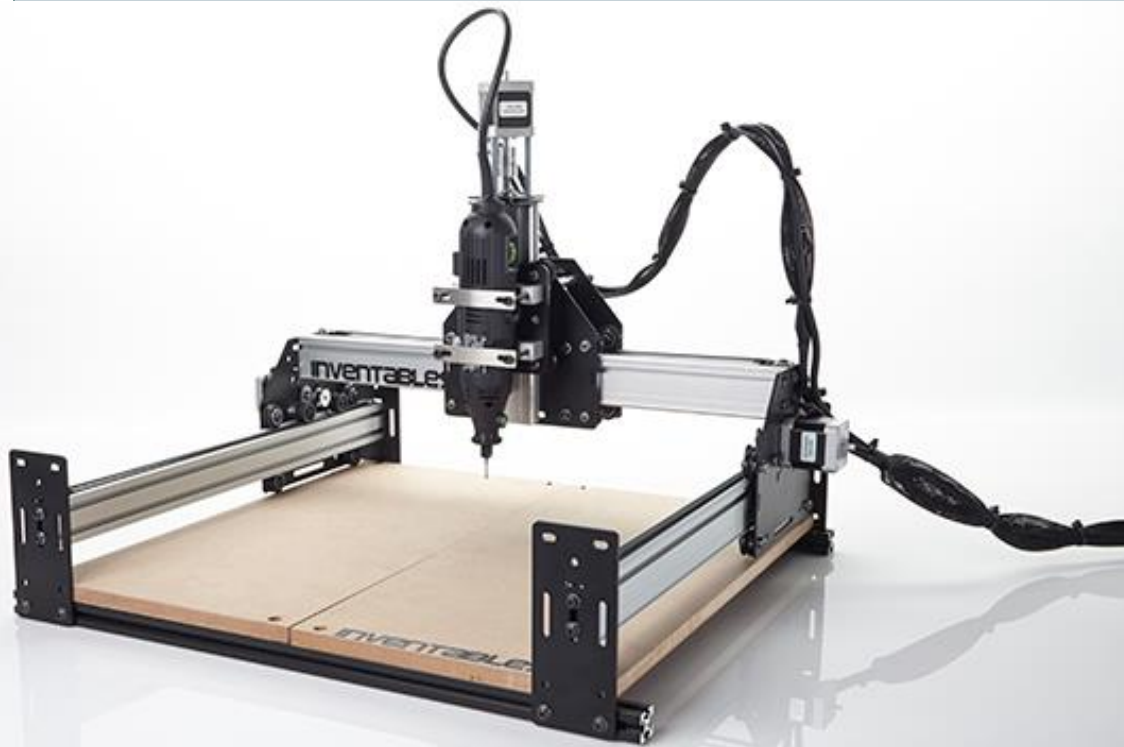

Question Time



GRAZIE PER L'ATTENZIONE

`callieri@isti.cnr.it`

`http://vcg.isti.cnr.it`

`http://vcg.isti.cnr.it/~callieri`

?

A red question mark inside a light blue speech bubble.

!

A blue exclamation mark inside a light blue speech bubble.

???

Three orange question marks inside a light blue speech bubble.

!

A blue exclamation mark inside a light blue speech bubble.

??

Two pink question marks inside a light blue speech bubble.

!

A blue exclamation mark inside a light blue speech bubble.